

Tous droits strictement réservés. Reproduction ou communication à des tiers interdite sous quelque forme que ce soit sans autorisation écrite du propriétaire. Propriété de c FCI. Droits de reproduction FCI.

All rights strictly reserved. Reproduction or issue to third parties in any form whatever is not permitted without written authority from the proprietor. Property of FCI. Copyright FCI.

PRODUCT NO.	ROWS	POWER				SIGNAL				POWER				E1		
		E2	P7	P6	P5	6	5	4	3	2	1	P4	P3		P2	P1
51897-005-- NOTE:3	D C B A															
		PH	PH	PG	F	F	F	F	F	F	F	PF	PF	PF	PF	HA
					F	F	F	F	F	F	F	F				

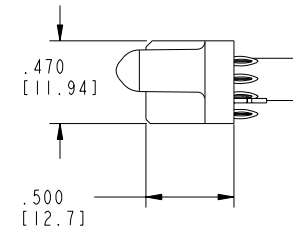
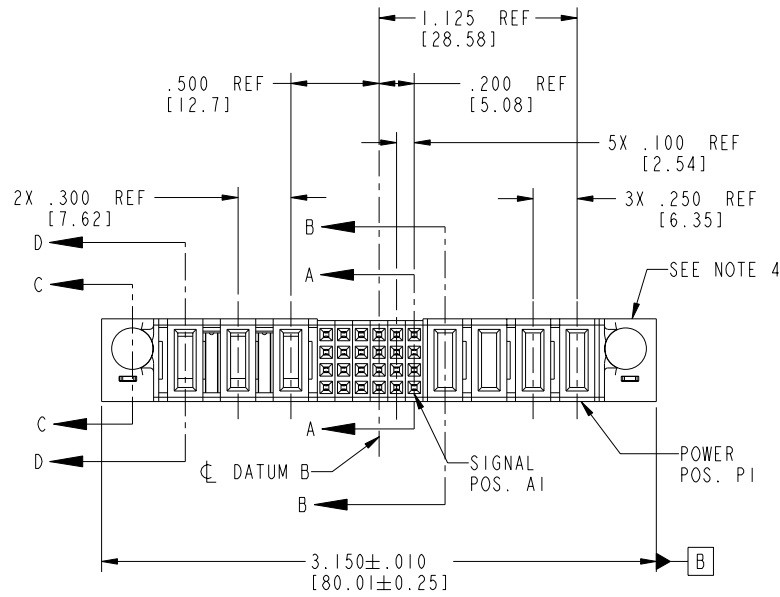
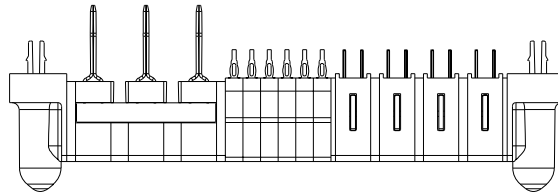

CODE	DIM "M" MATING LENGTH	CONTACT TYPE
PH	.092 [2.34]	POWER
PF	.092 [2.34]	POWER
F	N/A [N/A]	SIGNAL
HA	N/A [N/A]	HOLD-DOWN
PG	.042 [1.07]	POWER

mat'l code				SEE NOTE 2		tolerances unless otherwise specified		CUSTOMER	
ltr	ecn no.	dr	date	linear	.XX±.01/0.X±0.3	COPY		FCI www.fciconnect.com	
A	V03-0339	DAI	03/25/03	linear	.XXX±.005/0.XX±0.13	projection		title 4P + 24S + 3ACP	
B	DG05-0341	CS	09/23/05	angles	.XXX±.0020/0.XX±0.051			VERTICAL PRESS FIT RECEIPT CABLE PORT	
				dr	D. INGRAM 03/25/03	INCH/MM		product family PwrBlade code	
				enr	M. MOSTOLLER 03/25/03	scale 1:1		size dwg no 213	
				chr	M. MOSTOLLER 03/25/03			sheet 1 of 4	
				appd	M. MOSTOLLER 03/25/03			51897-005	
sheet index	revision sheet	B 1	B 2	B 3	B 4				

FCI www.fciconnect.com

product family PwrBlade code 213

size dwg no 51897-005 sheet 1 of 4

cage code 22526 4

Pro/E

PDM: Rev:B

STATUS:Released

Printed: Aug 15, 2007

Tous droits strictement réservés. Reproduction ou communication a des tiers interdite sous quelque forme que ce soit sans autorisation écrite du propriétaire. Propriété de c FCI. Droits de reproduction FCI.

All rights strictly reserved. Reproduction or issue to third parties in any form whatever is not permitted without written authority from the proprietor. Property of FCI. Copyright FCI.

PRODUCT NUMBER
51897-005_
NOTE: 3

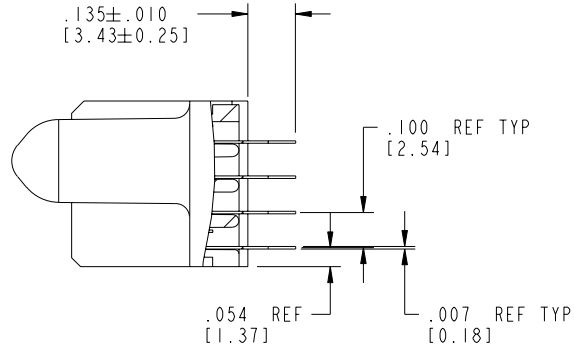

SECTION A-A
SCALE 2:1

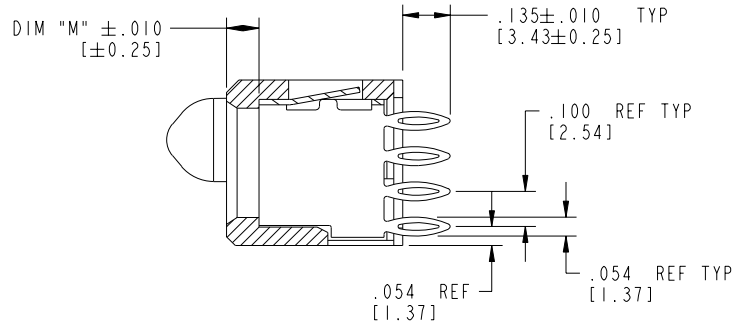

SECTION B-B
SCALE 2:1

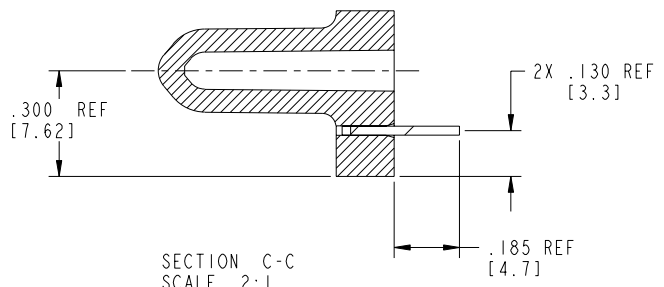

SECTION C-C
SCALE 2:1

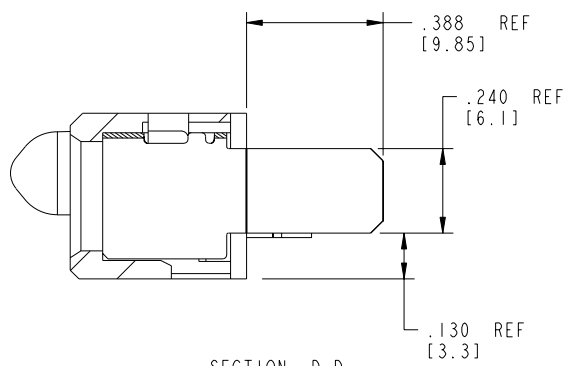

SECTION D-D
SCALE 2:1

mat'l code		SEE NOTE 2		tolerances unless otherwise specified		CUSTOMER		 www.fciconnect.com	
ltr	ecn no.	dr	date	linear	.XX±.01/0.X±0.3	COPY		projection	title
B					.XXX±.005/0.XX±0.13				4P + 24S + 3ACP VERTICAL PRESS FIT RECEIPT CABLE PORT
				angles	XXXX±.0020/0.XXX±0.051				product family
				dr	0°±2°			scale	PwrBlade
				engr	D. INGRAM 03/25/03			size	code
				chr	M. MOSTOLLER 03/25/03			A	213
				appd	M. MOSTOLLER 03/25/03			51897-005	sheet
sheet index	revision sheet								2 of 4

cage code 22526

Pro/E

PDM: Rev:B

STATUS: Released

Printed: Aug 15, 2007

Tous droits strictement réservés. Reproduction ou communication à des tiers interdite sous quelque forme que ce soit sans autorisation écrite du propriétaire. Propriété de c FCI. Droits de reproduction FCI.

All rights strictly reserved. Reproduction or issue to third parties in any form whatever is not permitted without written authority from the proprietor. Property of FCI. Copyright FCI.

PRODUCT NUMBER
51897-005_
NOTE: 3

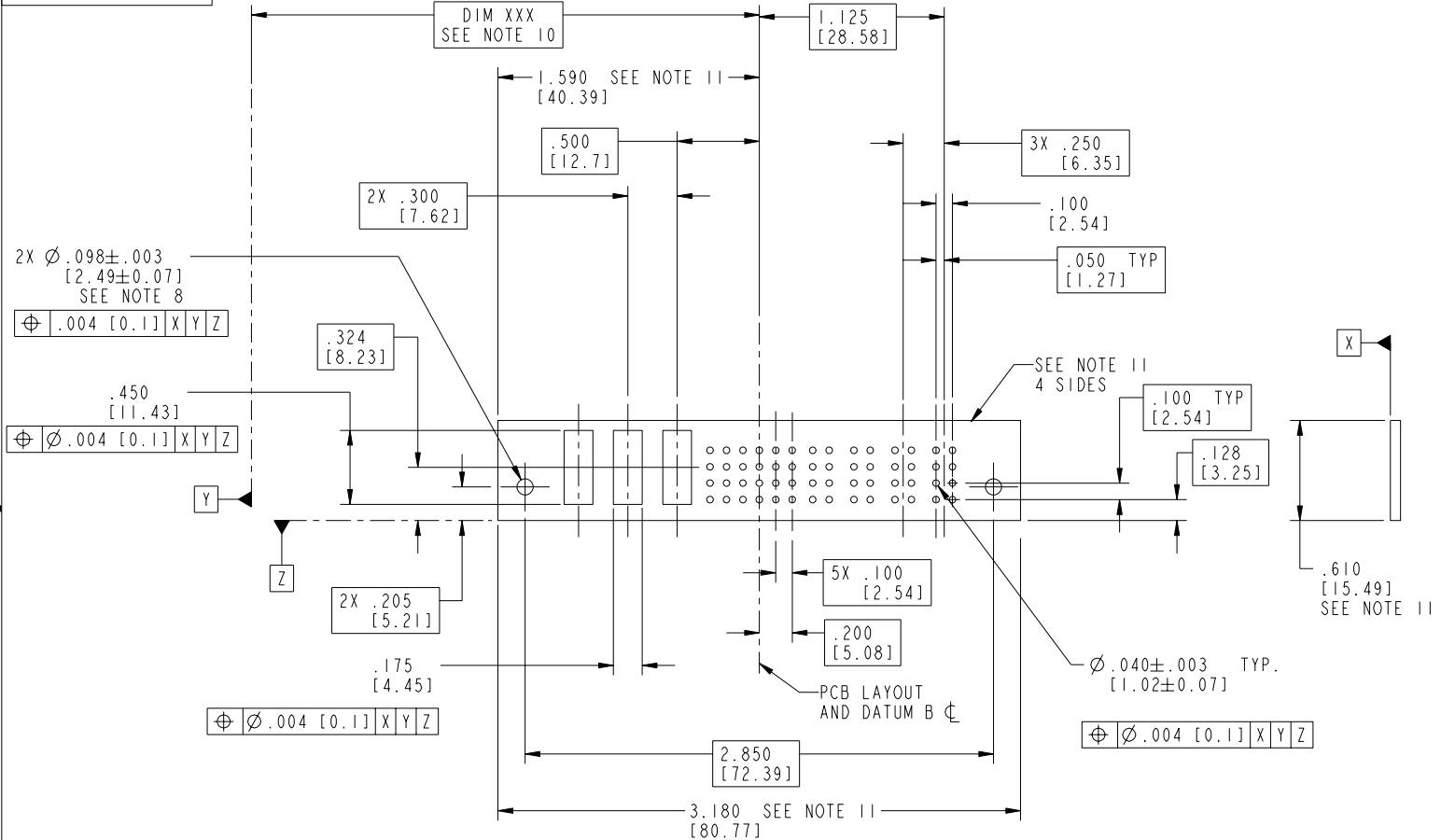

mat'l code				SEE NOTE 2		tolerances unless otherwise specified		CUSTOMER		 www.fciconnect.com	
ltr	ecn no.	dr	date	linear	.XX±.01/0.X±0.3	COPY		projection		title	
B					.XXX±.005/0.XX±0.13					4P + 24S + 3ACP VERTICAL PRESS FIT RECEPT CABLE PORT	
				angles	.XXX±.0020/0.XX±0.051					product family	
				dr	0°±2°			scale		PwrBlade	
				engr	D. INGRAM 03/25/03			size		code	
				chr	M. MOSTOLLER 03/25/03			A		213	
				appd	M. MOSTOLLER 03/25/03			51897-005		sheet	
sheet index		revision sheet								3 of 4	

cage code 22526

Pro/E

PDM: Rev:B

STATUS: Released

Printed: Aug 15, 2007

Tous droits strictement réservés. Reproduction ou communication a des tiers interdite sous quelque forme que ce soit sans autorisation écrite du propriétaire. Propriété de c FCI. Droits de reproduction FCI.

All rights strictly reserved. Reproduction or issue to third parties in any form whatever is not permitted without written authority from the proprietor. Property of FCI. Copyright FCI.

PRODUCT NUMBER
51897-005_
NOTE: 3

NOTES:
1. DIMENSIONS AND TOLERANCES ARE IN ACCORDANCE WITH ASME Y14.5M, 1994 UNLESS OTHERWISE SPECIFIED.

CONNECTOR NOTES:
② HOUSING MATERIAL: UL 94 V-0 GLASS FILLED
HIGH-TEMP THERMOPLASTIC
POWER CONTACT MATERIAL: COPPER ALLOY
SIGNAL PIN MATERIAL: COPPER ALLOY





3. PLATING:
51897-005 Singal Pin: 30u"/0.76um Au OVER 50u"/1.27um Ni ON THE CONTACT AREA,
AND 100u"/2.54um SnPb PLATING OVER 50u"/1.27um Ni ON THE TERMINATION SECTION.
Power Pin: 30u"/0.76um Au OVER 50u"/1.27um Ni ON THE CONTACT AREA,
AND 100u"/2.54um SnPb PLATING OVER 50u"/1.27um Ni ON THE TERMINATION SECTION.
51897-005LF Singal Pin: 30u"/0.76um Au OVER 50u"/1.27um Ni ON THE CONTACT AREA,
AND 78u"/2.00um Sn PLATING OVER 50u"/1.27um Ni ON THE TERMINATION SECTION.
Power Pin: 30u"/0.76um Au OVER 50u"/1.27um Ni ON THE CONTACT AREA,
AND 78u"/2.00um Sn PLATING OVER 50u"/1.27um Ni ON THE TERMINATION SECTION.

PART NUMBER 51897-005LF MEETS EUROPEAN UNION DIRECTIVE AND OTHER COUNTRY REGULATIONS AS DESCRIBED IN GS-22-008.

THE HOUSING WILL WITHSTAND EXPOSURE TO 260° PEAK TEMPERATURE FOR 10 SECONDS IN A WAVE SOLDER APPLICATION WITH A CIRCUIT BOARD.

④ MANUFACTURER'S NAME, P/N, AND DATE CODE TO APPEAR ON THIS SURFACE.
5. PRODUCT SPECIFICATION GS-12-149.
APPLICATION SPECIFICATION BUS-20-067.
6. PACKAGED IN TRAYS.
PCB NOTES:
7. ALL HOLE DIAMETERS ARE FINISHED HOLE SIZE.
⑧ MOUNTING HOLES, WHERE APPLICABLE, ARE UNPLATED.
⑨ $\varnothing .0453 \pm .0010$ [1.151 \pm 0.025] DRILLED HOLES PLATED WITH .0003 [0.008] MIN SnPb OVER .001 [0.03] TO .003 [0.08] Cu PLATING TO ACHIEVE $\varnothing .040 \pm .003$ [1.02 \pm .07] HOLE.

⑩ "DIM XXX" TO BE DETERMINED BY THE CUSTOMER.
⑪ CONNECTOR KEEP-OUT ZONE.

mat'l code				SEE NOTE 2		tolerances unless otherwise specified		CUSTOMER		 www.fciconnect.com	
ltr	ecn no.	dr	date	linear	.XX±.01/0.X±0.3	COPY		projection		title	
B					.XXX±.005/0.XX±0.13					4P + 24S + 3ACP VERTICAL PRESS FIT RECEPT CABLE PORT	
				angles	XXXX±.0020/0.XXX±0.051					product family	
				dr	0° ± 2°					PwrBlade	
				enr	D. INGRAM 03/25/03			size		code	
				chr	M. MOSTOLLER 03/25/03			A		213	
				appd	M. MOSTOLLER 03/25/03			51897-005		sheet	
										4 of 4	
sheet index	revision sheet										

cage code 22526 4